

Article number: 021816011194

Description: Clamp with bracket and rubber  
SPGU 6011. 194/30 SK

## Measures

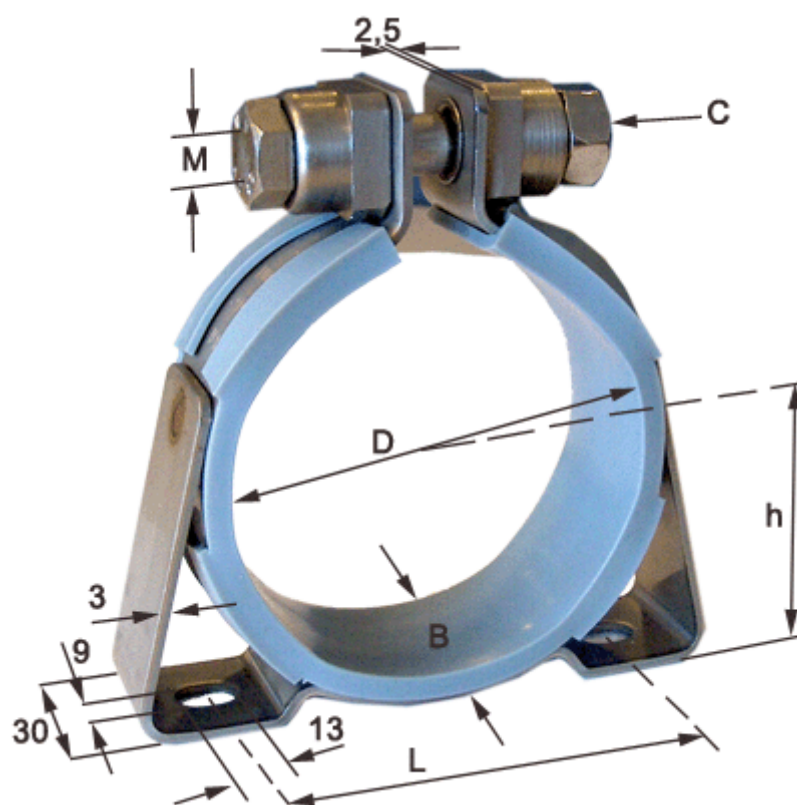

C (screw type) = SK hexagon screw

Diameter D = 194

h = 106

L = 148

Width B = 30